

work in silence.

BORG

eCell+

CONCEPT

DESIGN BY MARTIN SAAR

eCELL is a noise-reducing phone booth that makes you feel like you are the only one in the office. Its goal is to isolate and reduce the noise sources in an open office so that the individual does not disturb the co-workers and vice versa. It gives you enough privacy to focus and feel comfortable while keeping a visual contact with the surroundings. It has everything for an ease of use such as a fully integrated electrical connections (230V + 5V USB), LED lighting and constant fresh air circulation which are both triggered by a motion sensor to save energy. The first and only design to use fabric on the outer shell making it a cozy and inviting space to blend in your office.

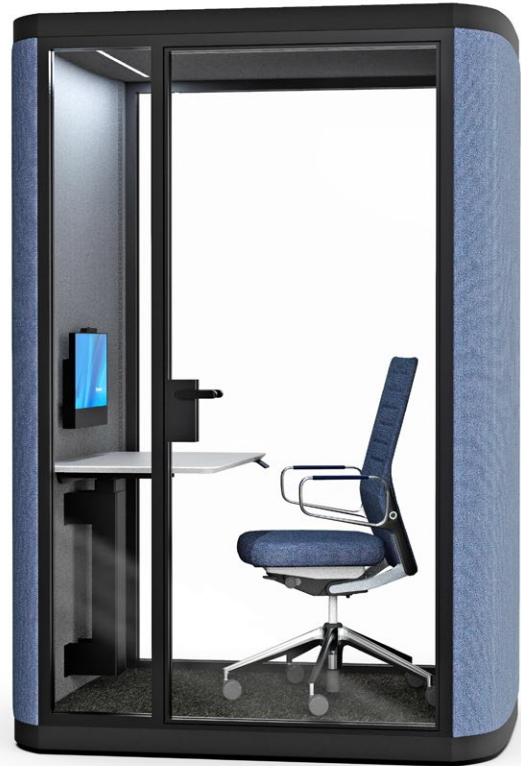

FEATURED ON
archiproducts®



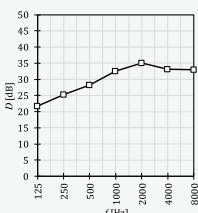

Test report

Borg phone and meeting booths have new ISO 23351-1:2020 certificate from University of Turku.



Test Report SY20-58.
Determination of speech level reduction according to ISO 23351-1:2020.
Speech level reduction DS,A was 29.0 dB.

Turku University of Applied Sciences,
Engineering and Business

-  Advanced layering and sound-absorbing materials
-  Motion sensor activated fresh airflow & lighting
-  Integrated power output 230V and 5V USB
-  Easy to move, booths are on castors
-  Quick and easy installation

eCell+

Technical specifications

Measurements	1500 x 1200 x 2200 mm (Width x Depth x Height)
Weight	385 kg
Glass	sound proof double glass, laminated and tempered, Rw 37
Floor	carpeting use class for public spaces
Power sockets	1 power socket / 1 USB A / 1 USB C
Frame	plywood 20mm, 10mm sound-proof mats, acoustic foam rubber
Seat	office chair
Ventilation	electrical ventilation system with motion sensor
Noise reduction	up to 29.0dB ISO 23351-1:2020
Airflow	26 l/s
Lighting	LED lighting
Castors	yes
Adjustable legs	for levelling

Materials used

- Acoustic felt has emission class A+ and VOC (France) A+
- Plywood and other composite materials used are CARB 2 compliant and have emission class E1
- Foams used in our products certified by and conform to the CertiPUR standard
- Acoustics foams have OEKO-TEX STANDARD 100 label
- WOOD GLUE: M1 Emission Classification certification
- All wood FSC / PEFC certified

Fabrics

Fabrics have OEKO-TEX STANDARD 100 label and are EU Ecolabel certified.

- Exterior fabric:
 - class 2 - Camira Advantage & Mainline Flax, Nevotex Wooly
 - class 3 - Gabriel Europost
 - class 4 - Camira Blazer & Synergy
 - class 5 - Kvadrat Stealcut 2 & Stealcut Trio 3
- Interior fabric: acoustic felt light or dark grey

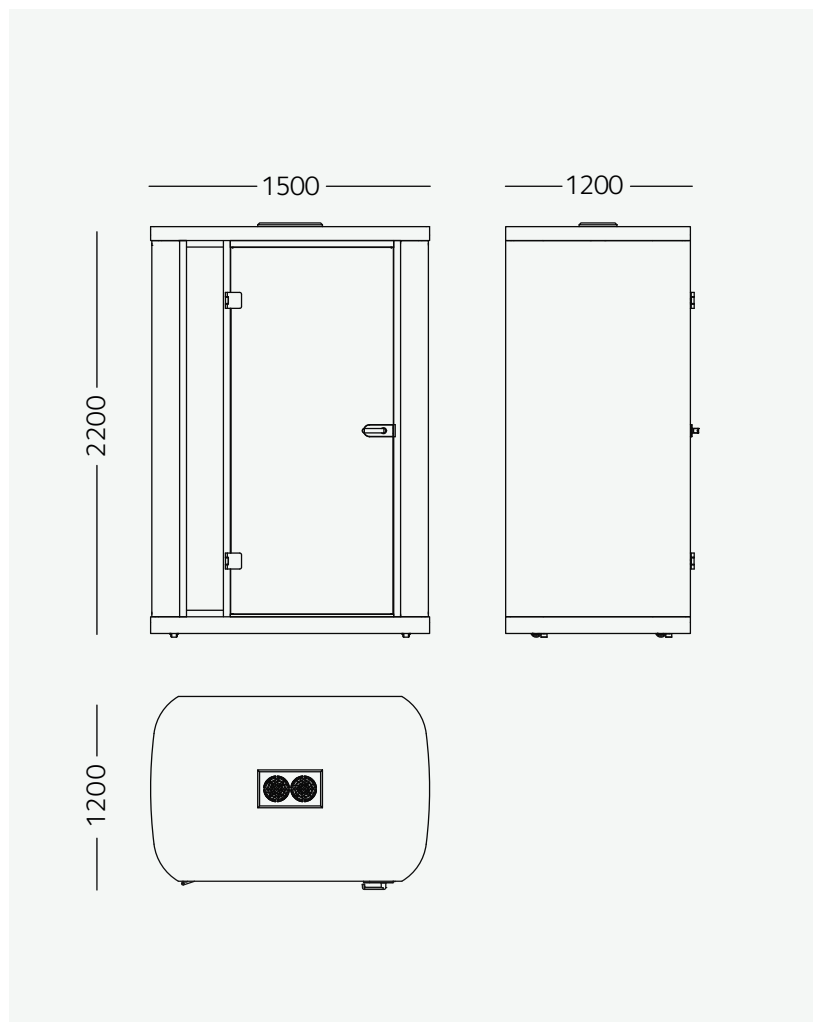

work in silence.
BORG

BORG

We value SUSTAINABILITY

Sustainability for us is not about big words, but about deeds. Even the smallest ones. About moral obligation. Our daily choices. The main principles of our company are avoiding overconsumption and building long-lasting furniture with timeless design.

At our work, we use eco-friendly materials and strive towards no waste production. As sensible people, we really love our common home, the air we breathe, and the water we drink. Because there is just no other way. No other plan.



Certificates

Our commitment to a sustainable tomorrow is confirmed through the certifications and labels on materials we use, it also includes regulations for formaldehyde use.

- Fabrics used in our products have **OEKO-TEX STANDARD 100** label and are **EU Ecolabel** certified
- Plywood and other composite materials used are **CARB 2** compliant and have **emission class E1**
- Foams used in our products certified by and conform to the **CertiPUR** standard
- Acoustics foams have **OEKO-TEX STANDARD 100** label
- WOOD GLUE: **M1** Emission Classification certification
- All wood **FSC / PEFC** certified
- FLOOR FINISHES certified by **GUT** or **The Blue Angel**



Components certificates



	COMPONENTS	SUPPLIER / product	CERTIFICATES	FIRE RATING	SOUND ABSORPTION	
	WALLS	Outside fabric	Camira / Main Line Flax	Oeko-Tex, Ecolabel	Class 1 or Class A	
	FLOOR	Flooring	Findeisen / Finett11	Blue Angel, GreenLabel, GUT	EN 13501-1, Bfl - s1	ISO 354, 21 dB
	WALLS & TOP	Inside accoustic felt	Beaulieu /Revexpo	CE, A+	A+, EN1307, Bfl -s1	
	WALLS	Glass	Andres Klaas / clear tempered laminated safety glass with EVA SC film	CE	EN 13501-2:2007+A1:2009	37 (0;-2)
	WALLS & TOP	Birch Plywood	UPM Kymmnen	M1, PEFC, FCS	ISO 12460-3:2015-11	
	WALLS & TOP	Building Veneer Plywood	Debpora Grupp / birch BF100	Carb2 compliant		
	WALLS & TOP	Flexible Polyrethane (PUR) foam	Carpenter Sweden AB / foam	Oeko-Tex		
	WALLS	*Wood glue	Kiilto/glue	M1		
	WALLS	Standard Ether Foam	Recticel OU/ foam	CERTIPUR		

* only component that is not recyclable

work in silence.

BORG

