

Talv

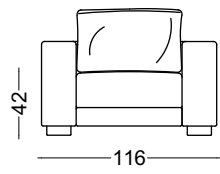

116

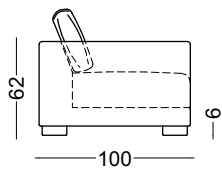
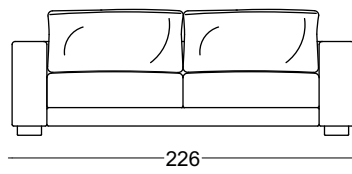

226

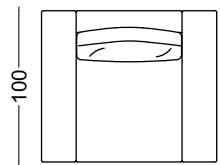

TLV/TT 116

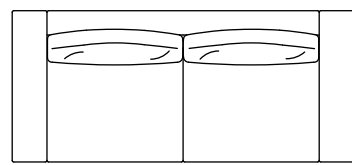

TLV/D 226

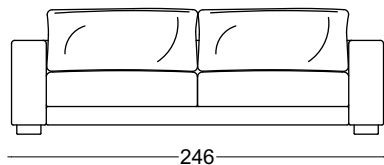

246

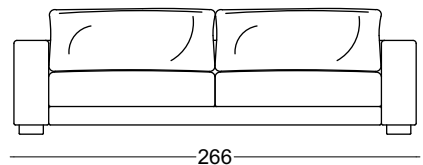

266

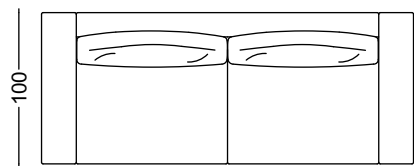

TLV/D 246

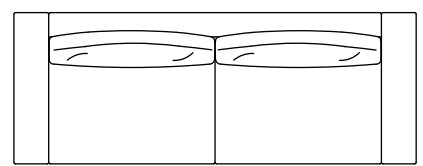

TLV/D 266

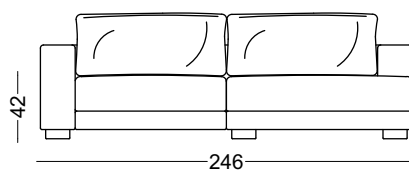
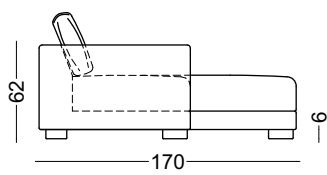

246

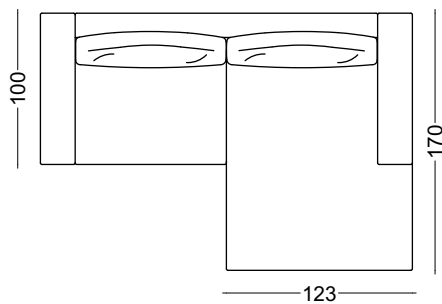

TLV/VP 246-170

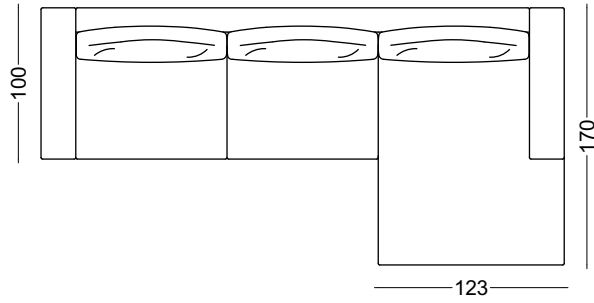
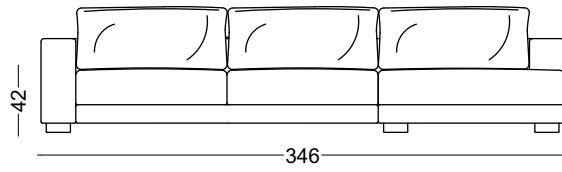
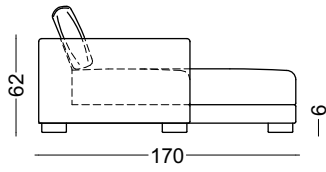

TLV/VP 346-170

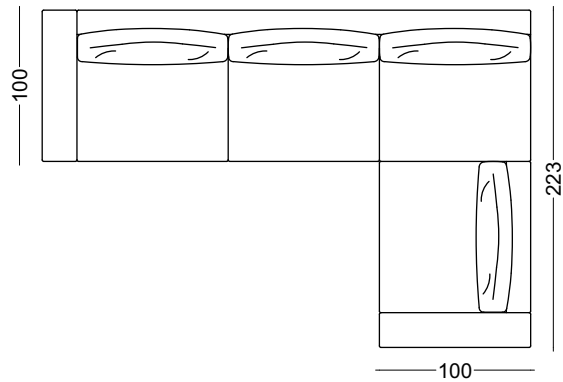
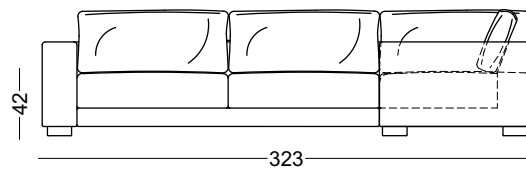
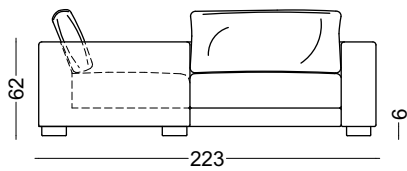

TLV/NP 323-223

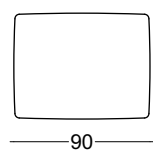
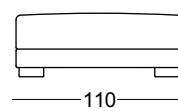
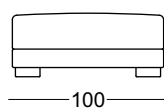
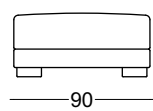
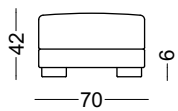

TLV/T 90

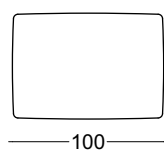

TLV/T 100

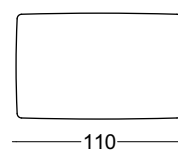

TLV/T 110